

■DESCRIPTION

The P-3548D Power amplifier delivers 480 W power output. It is so designed that its power ON/OFF can be remotely controlled when used in conjunction with A-3500/A-3600 Series mixer amplifier (option). The P-3548D can also be used as a stand-alone amplifier. It employs a PFC circuit.

■SPECIFICATIONS

Power Source	220 – 240 V AC, 50/60 Hz
Rated Output	480 W
Power/Current Consumption	601 W (rated output), 113 W (based on EN62368), 200 mA or less (when power switch is OFF)
Frequency Response	50 Hz – 20 kHz ±3 dB (1/8 rated output)
Distortion	1 % or less at 1 kHz, rated power (20 kHz LPF (AUX-0025))
Signal to Noise Ratio	88 dB or more (Master volume: min.) 76 dB or more (Master volume: max.) (A-weighted)
Audio Input	LINE IN: 0 dB (*1)/-20 dB (*1) (switchable), 600 Ω, transformer balanced, RCA pin jack × 2 SPEAKER LINE IN: 40 dB (*1) (100 V line), 65 kΩ, transformer balanced, removable terminal block (2 pins)
Audio Output	SPEAKER OUT: Low impedance (4 – 16 Ω)/High impedance (21 Ω), removable terminal block (3 pins) LINE OUT: 0 dB (*1), 600 Ω, unbalanced, RCA pin jack × 2
Control Input	POWER REMOTE IN: No-voltage make contact input, open voltage: 35 V DC or less, short-circuit current: 10 mA or less, removable terminal block (4 pins) EMERGENCY IN: No-voltage make contact input, open voltage: 35 V DC or less, short-circuit current: 10 mA or less, removable terminal block (4 pins)
Control Output	POWER REMOTE OUT: Open collector output, withstand voltage: 30 V DC or less, control current: 25 mA or less, removable terminal block (4 pins) EMERGENCY OUT: Open collector output, withstand voltage: 30 V DC or less, control current: 25 mA or less, removable terminal block (4 pins)
Indicators	5-point LED output level meter, Power indicator LED, Emergency indicator LED, Thermal protection indicator LED, Over current protection indicator LED
Operating Temperature	-10 °C to +40 °C (14 °F to 104 °F)
Operating Humidity	85 %RH or less (no condensation)
Finish	Panel: ABS resin, black Case: Surface-treated steel plate, black, paint
Dimensions	420 (W) × 96.1 (H) × 313.1 (D) mm (16.54" × 3.78" × 12.33")
Weight	5 kg (11.02 lb)
Accessory	Power cord (2 m (6.56 ft)) ---1, Audio input removable terminal plug (5 mm, 2 pins) ---1, Control I/O removable terminal plug (3.5 mm, 4 pins) ---2, Speaker out removable terminal plug (5 mm, 3 pins) ---1, Volume control cover ---1
Option	Rack mounting bracket: MB-25B Perforated panel : PF-013B

(\*1) 0 dB = 1 V

■ APPEARANCE

Rear View

1CE model

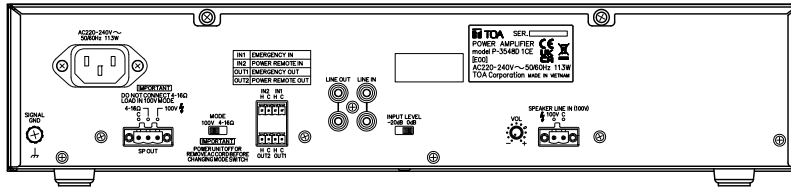

AC plug

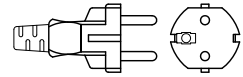

2CE model

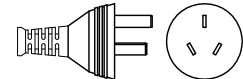
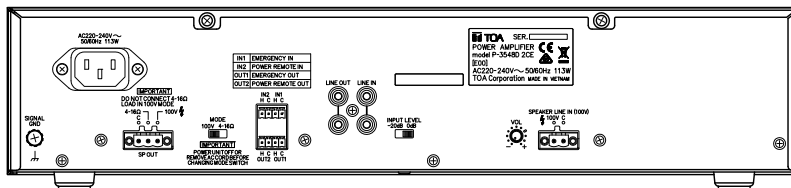

4CE model

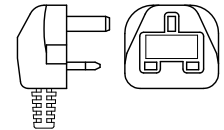
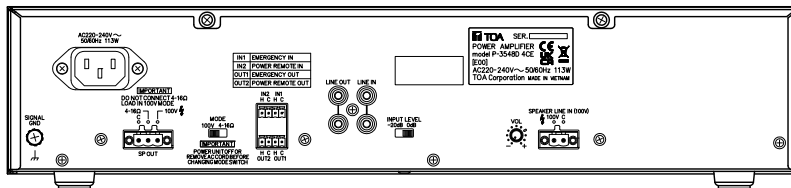

482.6 [19"]

466 [18.35"]

420 [16.54"]

Front View

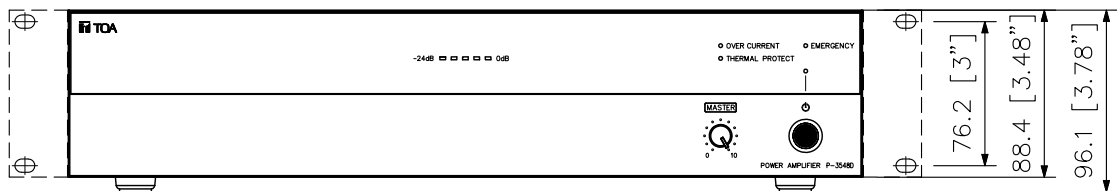

Side View

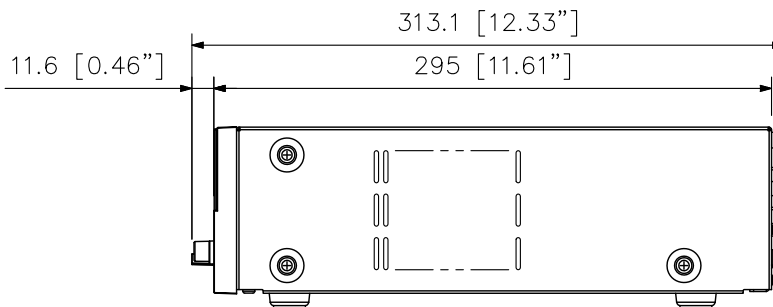

UNIT:mm SCALE:1/4